

Article number: 20990ALD202000EL

Description: E+G GN 990 Construction tube round
GN 990-AL-D20-2000-EL

Measures

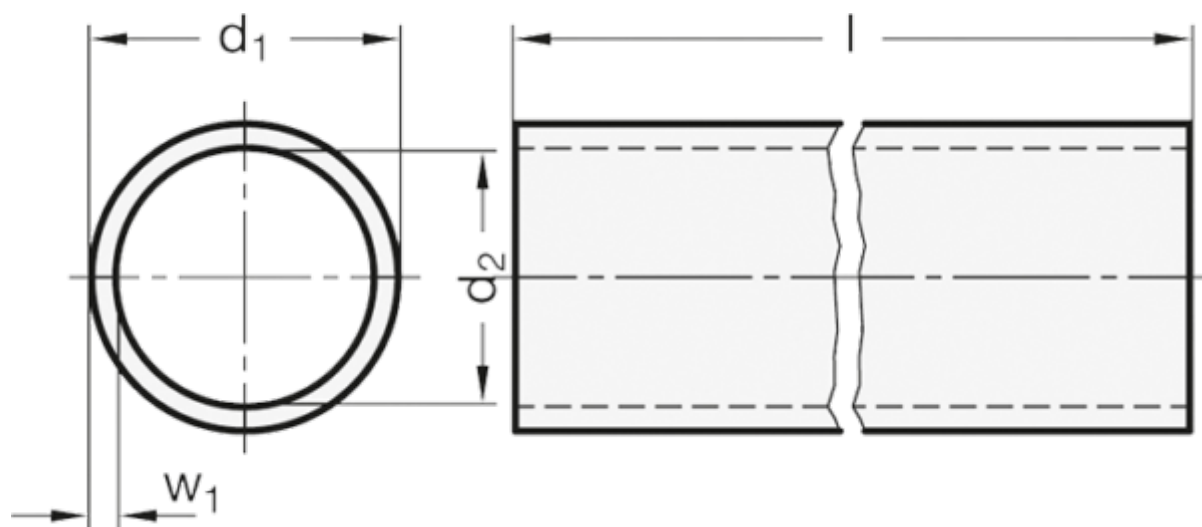

d_1 = D20 +0.1/-0.2

d_2 = 16

$l \pm 0.5$ = 2000

w_1 = 2

Weight in (g) = 610